

Energizer®

UE15032PQ

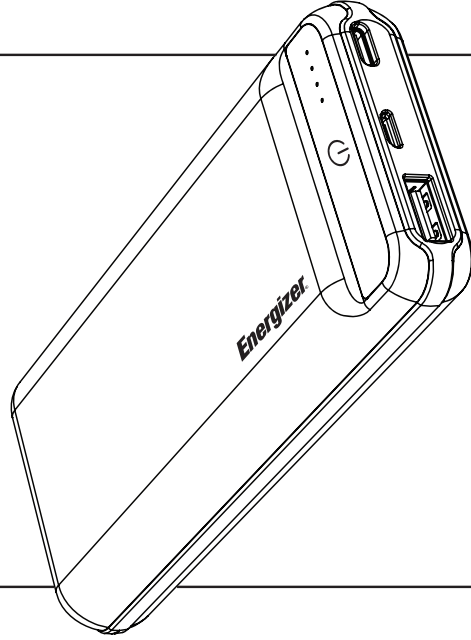

Includes

EN Specifications:
Model Name : UE15032PQ
Battery Cell : Lithium-Polymer
Power Capacity : 15000mAh @3.7V
Output WH : Max.55.5Wh
Rated Input : Micro USB 5V/2A
Rated Input : USB-C PD : 5V/2A, 9V/2A
Rated Output : USB A : 5V/3A, 9V/2A, 12V/1.5A
Rated Output : USB-C PD : 5V/2A, 9V/2A, 12V/1.5A
Total Output : 18W(Max.)
Dimensions : 150(L)*64(W)*24(H) mm
Weight : 280g±10g

FR Spécifications:
Modèle : UE15032PQ
Type de batterie : Lithium Polymère
Capacité : 15000mAh @3.7V
Sortie WH : Max.55.5Wh
Entrée :Micro USB 5V/2A
Entrée : USB-C PD : 5V/2A, 9V/2A
Sortie : USB A : 5V/3A, 9V/2A, 12V/1.5A
Sortie : USB-C PD : 5V/2A, 9V/2A, 12V/1.5A
Sortie Totale : 18W(Max.)
Dimensions : 150(L)*64(W)*24(H) mm
Poids : 280g±10g

DE Technische Daten:
Modell : UE15032PQ
Batterie : Lithium Polymer
Lade Kapazität : 15000mAh @3.7V
Ausgangsspannung WH : Max.55.5Wh
Eingangsspannung : Micro USB 5V/2A
Eingangsspannung : USB-C PD : 5V/2A, 9V/2A
Ausgangsspannung : USB A : 5V/3A, 9V/2A, 12V/1.5A
Ausgangsspannung : USB-C PD : 5V/2A, 9V/2A, 12V/1.5A
Gesamtleistung : 18W(Max.)
Abmessungen : 150(L)*64(W)*24(H) mm
Gewicht : 280g±10g

SP Especificaciones:
Modelo : UE15032PQ
Célula : Polímeros de Lito
Capacidad : 15000mAh @3.7V
Tensión de Salida WH : Max.55.5Wh
Tensión de Entrada : Micro USB 5V/2A
Tensión de Entrada : USB-C PD : 5V/2A, 9V/2A
Tensión de Salida : USB A : 5V/3A, 9V/2A, 12V/1.5A
Tensión de Salida : USB-C PD : 5V/2A, 9V/2A, 12V/1.5A
Producción total : 18W(Max.)
Dimensiones : 150(L)*64(W)*24(H) mm
Peso : 280g±10g

IT Specifiche tecniche:
Modello : UE15032PQ
Cellula di batteria : Polimero de Lito
Capacità : 15000mAh @3.7V
Potenza WH : Max.55.5Wh
Ingresso Nominale : Micro USB 5V/2A
Ingresso Nominale : USB-C PD : 5V/2A, 9V/2A
Potenza Nominale : USB A : 5V/3A, 9V/2A, 12V/1.5A
Potenza Nominale : USB-C PD : 5V/2A, 9V/2A, 12V/1.5A
Output Totale : 18W(Max.)
Dimensioni : 150(L)*64(W)*24(H) mm
Peso : 280g±10g

Package Contents

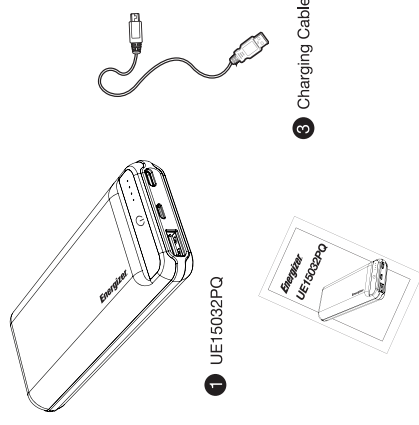

1 UE15032PQ

3 Charging Cable

2 User Manual



PowerSafe Management

Guarantees against short circuit and over-charging for your power bank and devices.



Customer Service
For any question about the product, please contact us at service@energizerpowerbanks.com

© 2019 Energizer. Energizer and certain graphic designs are trademarks of Energizer Brands, LLC and related subsidiaries and are used under license by TennRich International Corp. All other brand names are trademarks of their respective owners. Neither TennRich International Corp. nor Energizer Brands, LLC is affiliated with the respective owners of their trademarks.

How to USE

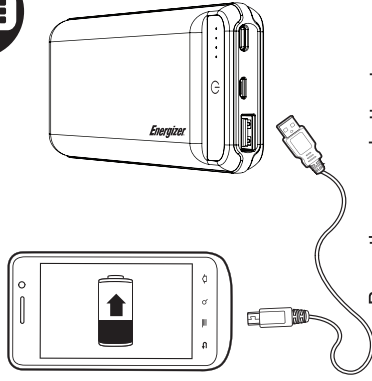

Press the power button to activate charging on your device(s)

For fast charge, please charge only one device at a time
Please use compatible cable and/or adapter to activate QC or PD fast charge

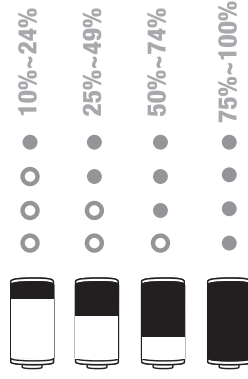

Blinking light indicates charging.
Solid light indicates fully charged.

How to Recharge

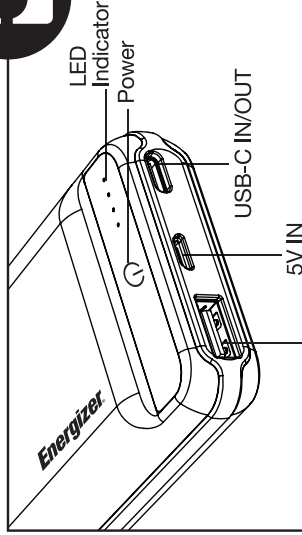
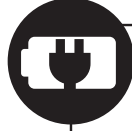

Smart USB 18W Output

Connect the micro-USB or USB-C end to the input port to recharge

Connect the charging cable to a universal USB AC adapter.

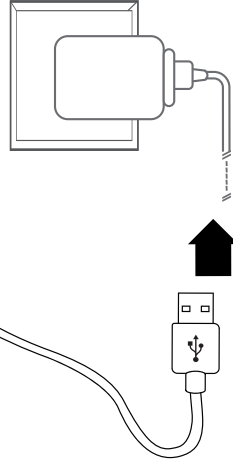

Adapter not included

Safety Instruction

- Avoid water, heat, fire, penetration of the battery, and severe drops at all times.
- Do not insert other objects into the USB ports other than the USB connectors.
- Once the product is fully charged, your power pack automatically shuts off to save power.
- During charge and recharge, battery may feel slightly warm, do not worry, this is normal
- Do not clean the battery with water or other cleaning products, clean the exterior with a lightly wetted cloth or napkin
- Any intentional and physical damage to the battery will not be under the warranty conditions
- Battery storage temperature is between 10°C--60°C , operating temperature is 0°C--45°C
- Fully charge the battery before first use to maximize the battery life
- Recommend to recharge your power bank with a wall charger/adapter.
- For better performance, avoid recharging the power bank while your device is connected to it.

WARRANTY

All products from the date of purchase are qualified for limited time warranty. For more warranty information, please visit: <http://www.energizerpowerbanks.com>

GARANTIE

Alle Produkte eignen sich ab dem Kaufdatum zu einer beschränkten Qualitätsgarantiezeit. Für zusätzliche Garantieleistungen Alleen Sie bitte auf: <http://www.energizerpowerbanks.com>

GARANTIA

Tous les articles bénéficient d'une garantie limitée dans le temps à partir de la date d'achat. Pour plus d'informations concernant la garantie, merci de visiter notre site : <http://www.energizerpowerbanks.com>

GARANZIA

Tutti i prodotti, a partire dalla data di acquisto, hanno la certificazione sulla qualità per un periodo limitato di tempo. Per ulteriori informazioni sulla garanzia si prega di visitare il sito: <http://www.energizerpowerbanks.com>

GARANTIA

Todos los productos desde la fecha de compra gozan de la garantía de tiempo limitado. Para más información sobre la garantía, puede visitar: <http://www.energizerpowerbanks.com>



Dispose the battery properly, seek for local disposal facility for advice.
Do not dispose, disassemble, damage, or incinerate the battery at all time.